

Pacific Antenna Easy SWR Indicator Kit

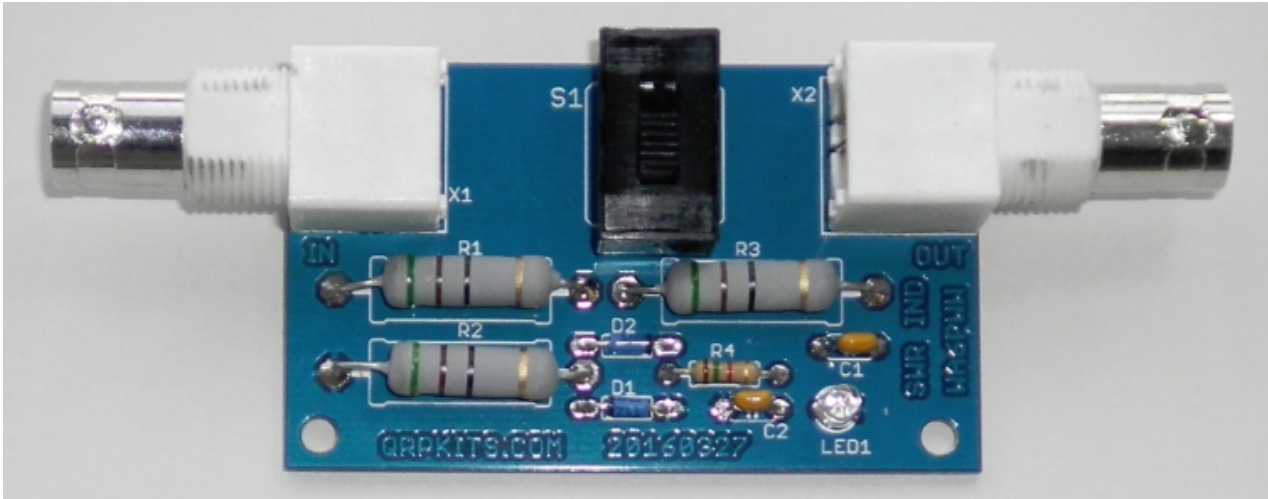

Description

Monitoring the match of an antenna to your transmitter or adjusting an antenna tuner for best match requires an indicator of the reflected power as an indication of how well the antenna is matched to the transmitter.

Displays reflected power level through the brightness of an LED.

Using this bridge, the antenna or tuner are adjusted for the minimum LED brightness and in most cases, the LED will completely extinguish.

The resistive bridge limits the mismatch seen by the transmitter and protects your transmitter from seeing high SWR.

A very easy kit to assemble and does not require winding any toroids or any adjustments.

Recommended it as a great kit for new or returning builders.

Specifications

Recommended for power levels of 0.2 to 5 watts

Works from 160M to 6M

Provides protection for transmitter by limiting reflected power during tuneup

Indicates match to antenna by dimming or extinguishing of LED

Constructed on a 1.5x 2.5 inch printed circuit board

Includes board mounted BNC connectors.

Support

PACIFIC ANTENNA

QRP KITS.COM

qrpkits.com@gmail.com

Tools Needed

- Temperature Controlled Soldering Station with small tip or 15-35 watt soldering iron with small tip.
- Solder 60/40 or 63/37 Tin-Lead
- Small Diagonal Cutters
- Small Needle Nose Pliers
- Pencil, Pen, and/or Highlighter
- BRIGHT work light

Optional

- Magnifying headpiece or lighted magnifying glass.
- Multi-meter
- Solder Sucker or Solder Wick
- Small multi-blade Screw Driver
- Knife or Wire Stripper
- Small Ruler
- Cookie Sheet to build in and keep parts from jumping onto the floor.

Construction Techniques

- Please take time to inventory the parts before starting and report any shortages to QRPKITS.com
- Pre-sorting the resistors and capacitors can speed up the assembly and reduce mistakes.
- You can insert several parts at a time onto the board. When you insert a part bend the leads over slightly to hold the part in place, then solder all at the same time. Clip the leads flush.
- Most parts should be mounted as close to the board as possible.
- It is best to use a Temperature Controlled Soldering Station with small tip or a 15-35 watt soldering iron with small tip. Conical or very small screw driver tips are best.
- If you are a beginner, new to soldering, there are a number of resources on the web to help you get on the right track soldering like a pro. Google Soldering Techniques.

Here is one good example:

http://www.elecraft.com/TechNotes/NOSS_SolderNotes/NOSS_SolderNotesV6.pdf

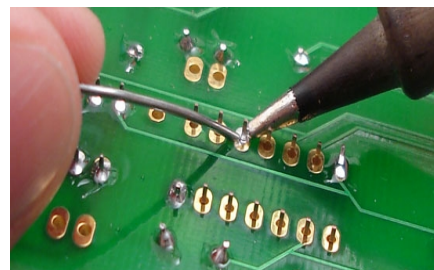
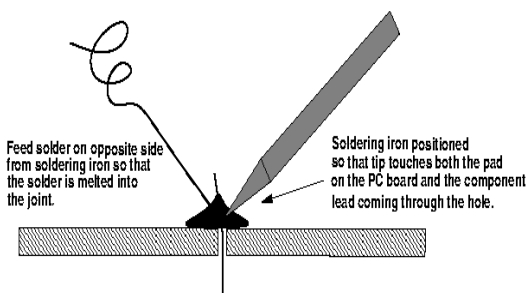

Parts

Use the photograph to help identify parts in your kit. Note that in some cases parts may vary slightly in appearance from those shown.

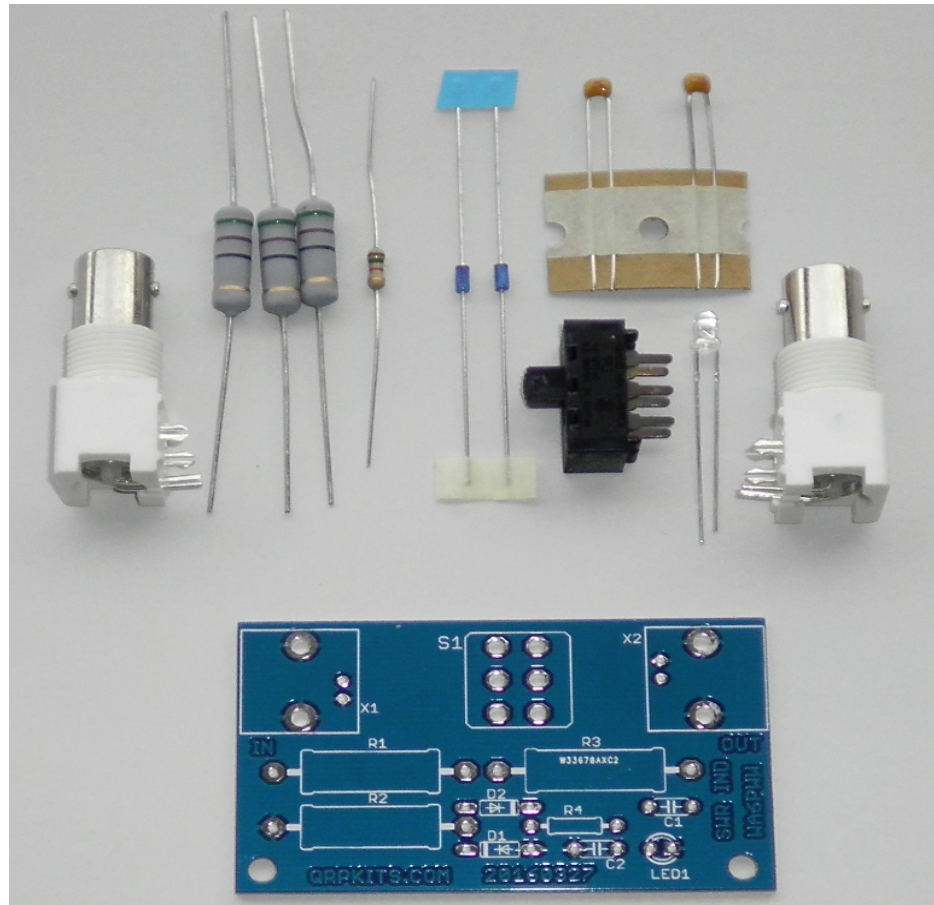

Use the first column of the table below to check the parts as you inventory them and use the second column to check the parts as you install them.

Parts Table

Inventory	Installed	Part #	Quantity	Description	Identification
		PCB	1	SWR IND	SWR IND
		R1,R2,R3	3	51 Ohm 2W resistor	GRN-BRN-BLK-GOLD
		R4	1	1.5K Ohm 1/4W resistor	BRN-GRN-RED-GOLD
		D1, D2	2	1N5711	Schottky Diode
		C1, C2	2	0.01uF Capacitor	Monolythic marked 103
		LED1	1	LED	LED
		S1	1	DPDT Switch	Metal frame or black plastic
		J1, J2	2	BNC	Board or Panel mount BNC

Inserting the Parts

Install the components listed in the table.

For resistors, and diodes, you can preform the leads by bending them down at a 90 degree angle.

Match the distance from the body to the holes in the circuit board where the part will be located.

Once each part is installed, bend its leads on the bottom of the board to hold it in place, solder the leads and clip off the excess lead.

Resistors

Locate and install the 1.5 k Ohm resistor R4 in the marked location on the board. It is the only small, ¼ watt resistor in the kit and is color coded Brown-Green-Red-Gold.



Now locate and install R1, R2 and R3 in the locations marked on the PC Board. These are larger body, 51 Ohm, 2W resistors with color code Green-Brown-Black-Gold.

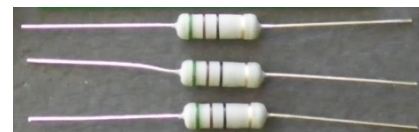

Capacitors

Install the capacitors C1 and C2 in the locations marked on the board. They do not have any specific orientation.

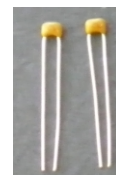

Diodes

Install the two Diodes D1 and D2, making sure to orient the diode bodies so that the band on the diode is on the same end as shown on the circuit board.

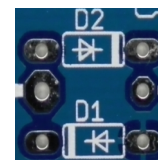

LED

Install the LED. It has specific polarity and must be installed only one way in the board or it will not work. It has one lead that is longer (the anode) and one shorter (the cathode)

The body of the LED will also usually have a flat on the same side as the short lead.

The circuit board has a round pad and square pad at the LED location. To install, insert the LED so that the short lead goes into the square pad on the board and the longer lead into the round pad.

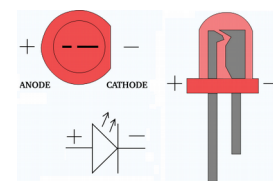

BNCs

Note: If you plan to mount this kit in a case or build into another assembly where input and output connectors will not be needed or if you are using connectors to be mounted on the case you will not want to install the on board BNCs.

Solder the supplied BNC connectors on each end of the board in the positions marked J1 and J2. Be sure that the connectors are fully seated and then solder the support pins one at a time.

After the first support pin is soldered, recheck that the connector is seated on the board. If not, reheat the connector support pin while pressing down on the board to fully seat it.

Once the connectors are seated and both support pins are soldered, go ahead and solder the two signal connection pins (smaller) on each BNC.

Switch

Install the supplied DPDT switch in position S1 on the board. The orientation does not matter.

Solder 1 pin first and check that the switch is seated on the board. If not, heat the soldered pin while pressing the switch into the board and hold it while the solder solidifies.

Repeat this with a pin on the opposite end of the switch. This will hold it in place while the other 4 pins are soldered.

Checkout

Inspect the board for any bad solder joints, shorts or other problems and correct before use. Confirm for proper orientation of the LED and diodes.

Using a multi-meter in resistance mode, measure the resistance between the center and shell of the input BNC connector X1 (or pads on the board if BNCs are not installed).

With the switch in bypass (toward the edge of the board, away from the diodes), the resistance should indicate open or infinite.

With the switch down toward the diodes to put the bridge in the circuit, you should see approximately 100 Ohms.

Repeat this check on the output BNC,

With the switch in bypass, you should also see infinite resistance and with the bridge switched in you should see approximately 150 Ohms.

Check resistance from the center of the input to the center of the output BNC.

With the bridge switched out (switch away from the diodes), you should see a very low resistance, less than 1 ohm.

With the switch down toward the diodes, you should measure approximately 50 Ohms

Congratulations, you have completed assembly of your Easy SWR Indicator Kit!

RF tests

We will perform functionality tests by connecting a transmitter (5W maximum) to the input of the Easy SWR Indicator.

Place the bridge in circuit by moving the switch to the position closest to the diodes.

Leave the output unconnected and very briefly key the transmitter.

You should see the LED light indicating correct installation of the diodes and LED.

To further test, if you have a 50 Ohm load or dummy load, connect it to the output and briefly key the transmitter. The LED should not light.

This completes functional testing and your Easy SWR Indicator is ready to use!

Packaging

Packaging is left up to the builder. The kit can be used as is, built into another assembly or installed in a case.

Usage

The Easy SWR Indicator provides a means to monitor the match between your antenna and transmitter to avoid damage and ensure maximum power transmission.

When the Switch S1 is toward the edge of the board, the bridge is bypassed.

When the switch is down (toward the diodes), the bridge is in series with the antenna and will indicate mismatch by the brightness of the LED.

Adjusting your antenna or antenna tuner will cause the LED to dim and in most cases, completely extinguish when you have a good match.

Once a match is achieved, switch the Easy SWR Indicator out of the circuit by placing the switch in bypass position as shown below.

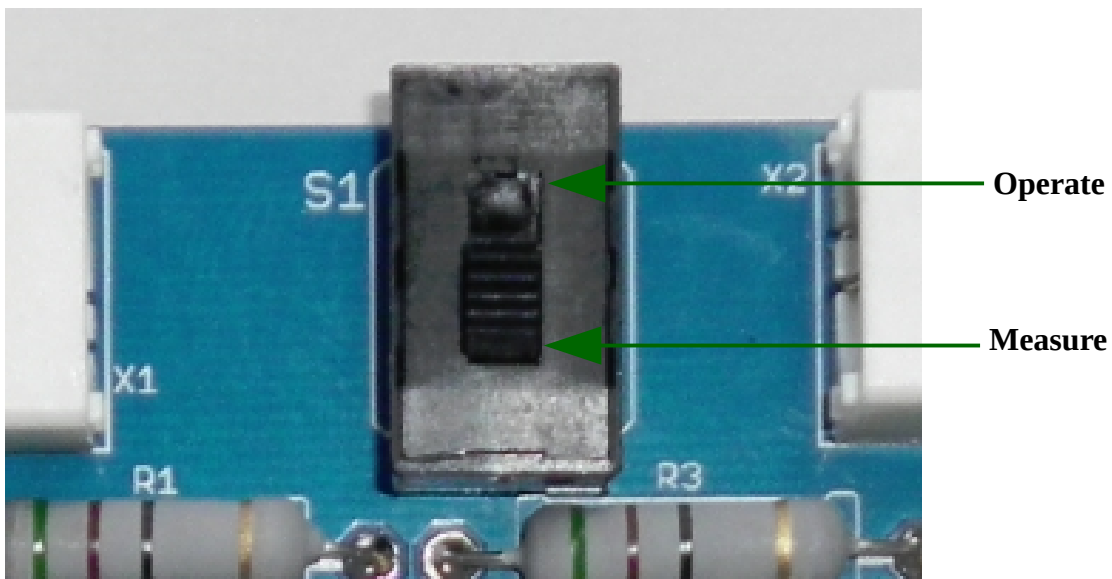

Board Layout

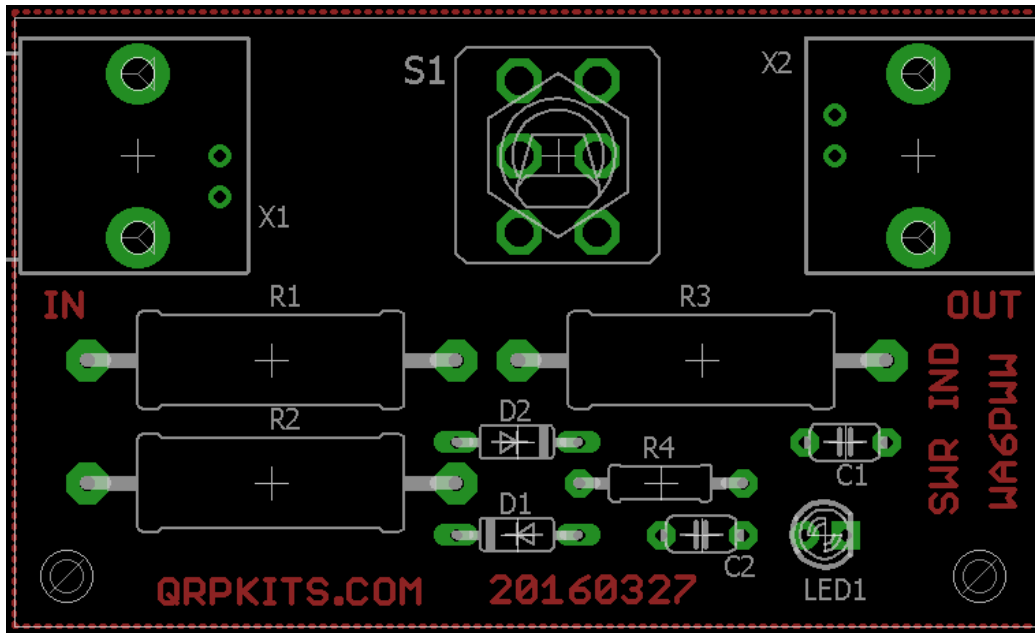

Schematic Diagram

